

PRELIMINARY TECHNICAL INFORMATION
HIGHLIGHTS

- Stop/start box up to 12 A_{RMS}.
- Suitable for motors or machine tools up to 1.5 HP.
- 230/400 V_{AC} mains voltage input.
- Single phase and three-phase.
- Prepared to add external emergency contacts.
- Prepared to add external power contactors.
- Plug & Play, all included.



non-contractual photo

SC-MP06LC is a ready-to-use Stop/start box with emergency push button which already incorporates all electronics and relays necessary to use it directly interfacing your load or machine tool providing up to 12 A_{RMS} or capable to start/stop motors or machine tools up to 1.5 HP.

The box includes a Stop/start push button, an emergency button and a cable gland.

TECHNICAL SPECIFICATIONS

Description	notes/test conditions	min	typ	max	
Mains input voltage ⁽¹⁾	V _{IN AC} 230V Configuration	213	230	275	V _{AC}
	V _{IN AC} 400V Configuration	340	400	440	V _{AC}
Mains frequency	f _{AC}		50/60		Hz
Output current	I _{OUT AC1} AC-1			12	A
	I _{OUT AC3} AC-3			3.26	A
Output power	P _{OUT AC1} AC-1, 3-phase, 230V _{AC}		4000		VA
	P _{OUT AC1} AC-1, 3-phase, 400V _{AC}		6950		VA
	P _{OUT AC3} AC-3, 3-phase, 230V _{AC}		0.85		HP
	P _{OUT AC3} AC-3, 3-phase, 400V _{AC}		1.5		HP
Protection degree			IP-54		
Combustibility class			UL94 V-0		
Storing temperature range	T _{stg}	-40		80	°C
Operating temperature range	T _{op}	-10		35	°C

Data at T_a = 25 °C and rated values, unless otherwise indicated.

(1) See JUMPER SETUP (230 V_{AC} / 400 V_{AC} OPERATION).

CONFORMALS

Conformal coating

MIL-1-46058, Type UR

Security

EN60950-1, UL60950-1

CE Marking



151026 Rev.:2

MECHANICAL DIMENSIONS

<i>Description</i>		
Box dimensions	164 x 12x 125	mm
Weight (aprox.)	680	g

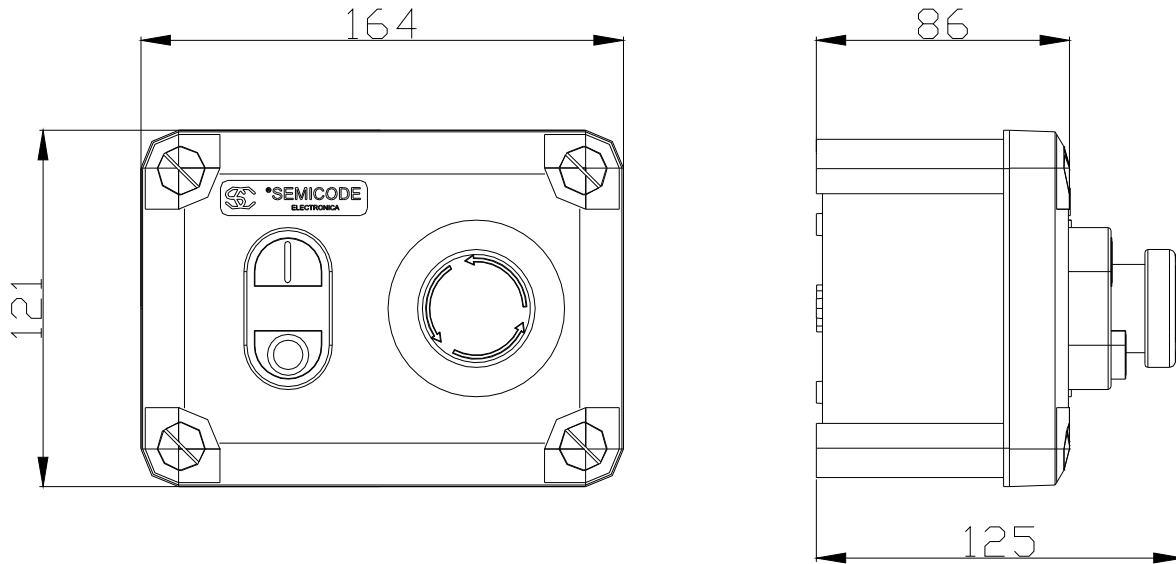

All dimensions in mm.

INTERNAL CONNECTIONS

Description	notes/test conditions	min	typ	max
Device configuration	On-board jumpers (see jumpers set up)			
I/O Power connections	Plug connectors, with screw . Type CIF (Sauro)			
Connectors fixing screw torque			5.0	Nm
Cable section Sauro CIF		30		12 AWG
Maximum current per contact				12 A

ACCESSORIES

The stop-start box is supplied with the following accessories:

- Cable gland for input/output wiring.
- All mating pluggable connectors.

TYPICAL APPLICATION, DEFAULT CONNECTION

On figure 1 is depicted the typical connection for a 3-phase use of the Stop/start box. Note that by default, if there is no use of external emergency button, a bridge between poles PE1 and PE2 on J2 is done. Otherwise see “WIRING ADDITIONAL EMERGENCY STOPS”.

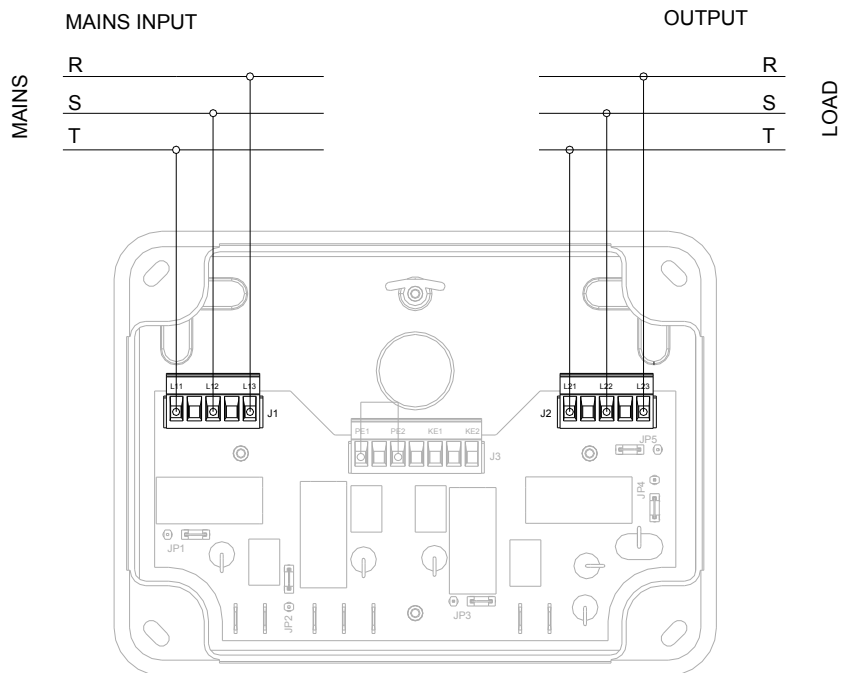

figure 1: 3-phase Typical wiring application. Internal view of stop/start box.

START/STOP BOX CONNECTORS PINOUT

J1 CONNECTOR

#pin	Designator	Function
1	L11	Mains Input AC Line R
2		Not implemented
3	L12	Mains Input AC Line S
4		Not implemented
5	L13	Mains Input AC Line T

J2 CONNECTOR

#pin	Designator	Function
1	L21	Mains Output AC Line R
2		Not implemented
3	L22	Mains Output AC Line S
4		Not implemented
5	L23	Mains Output AC Line T

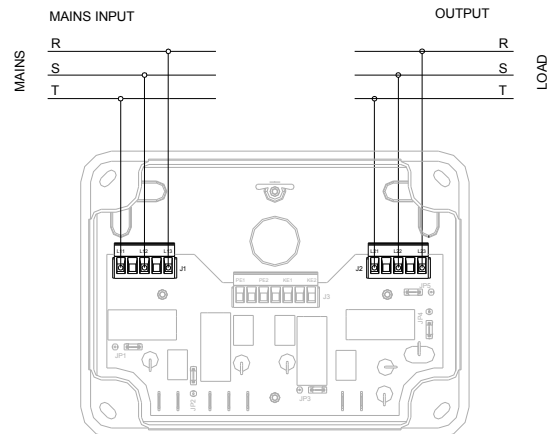

figure 2: Wiring of input and output mains on a three-phase application.

JUMPERS SETUP (230 V_{AC} / 400 V_{AC} OPERATION)

Prior to its connection user must ensure the correct set up of the internal PCB on-board jumper configuration according the input application voltage. Following you will find the two available configurations, 230 V_{AC} configuration and 400 V_{AC} configuration.

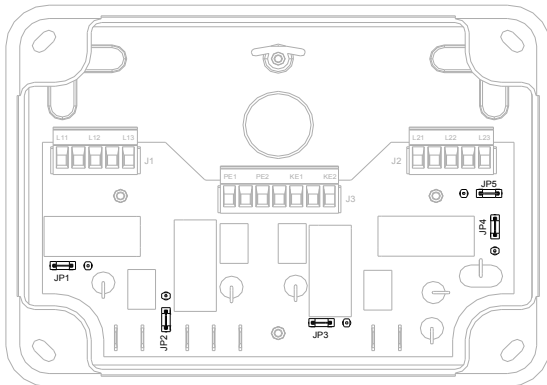

figure 3: Detail of jumpers collocation for 230V_{AC} operation.

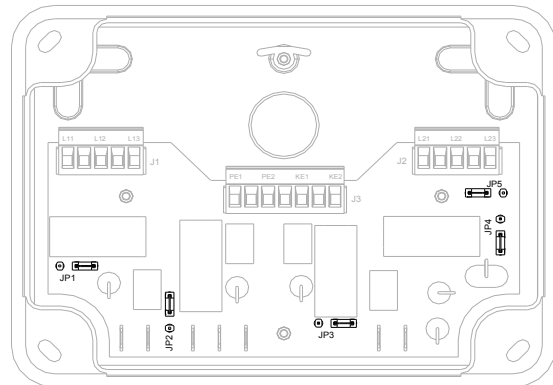

figure 4: Detail of jumpers collocation for 400V_{AC} operation.

230 V_{AC} JUMPERS

#pin	Function
1	LEFT
2	DOWN
3	LEFT
4	UP
5	RIGHT

400 V_{AC} JUMPERS

JUMPER	Position
1	RIGHT
2	UP
3	RIGHT
4	DOWN
5	LEFT



Warning Note:

By default SC-MP06HE is supplied to work on 400 V_{AC} mains power supply. Please check your application needs; **operating at 400 V_{AC} when the board is configured to work as 230 V_{AC} can damage the system.**

WIRING ADDITIONAL EMERGENCY STOPS

SC-MP06HE allows to easily add external Emergency stop buttons that will act as the main emergency button on box. This additional Emergency Button is internally wired in series connection with the main Emergency button on the box lid.

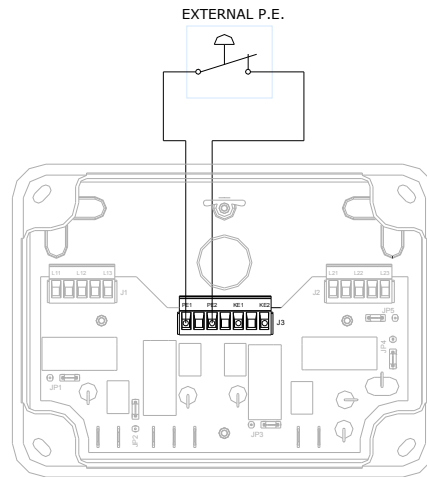

figure 5: Wiring scheme to add additional Emergency stop push buttons.

Please remember that when no additional external emergency stop is used it is necessary to wire a jumper between PE1 and PE2 on J3 connector as is shown in the typical application on figure 5. This jumper is wired by default.

USING AN EXTERNAL POWER CONTACTOR

When driving an external power contactor please consider the maximum current admissible of 3 A_{RMS} (AC-15). The external contactor must be wired as is shown on figure 6. The driving coil voltage on the external power contactor when ON will be the same line mains voltage of the application.

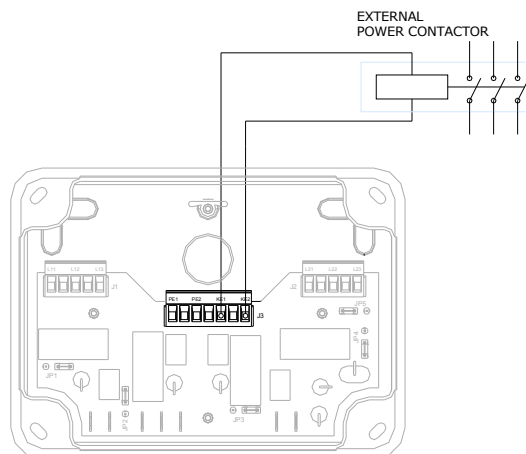

figure 6: Wiring scheme to add an external power contactor.

USING THE START/STOP BOX ON A SINGLE-PHASE MAINS SUPPLY

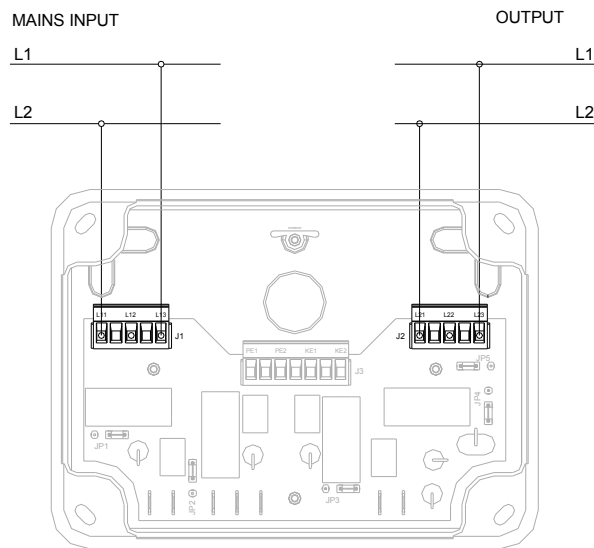

figure 7: Wiring scheme for single phase scheme.

When used on single phase applications the mains and output wiring must be made as is shown on figure 7 leaving the L12 from J1 connector and L22 from J2 connector contacts unconnected.

Cost Effective Products

SEMICODE ELECTRONICA

Offers to the market a comprehensive range of products from recognized manufacturers at the best price/quality relationship, this products are provided with a basic reference code that allows maintaining the same product reference even if the original device manufacturer is replaced. SEMICODE product reference has to be considered as a generic brand.

Seeking the market needs and trends, we are constantly increasing the product portfolio with new products and suppliers, please ask for the updated information available to our local contacts.

SEMICODE products include semiconductors, passive components and accessories focused in power electronics market.

Datasheet Annotations:

SEMICODE ELECTRONICA annotate datasheets in the top left hard corner of the front page, to indicate product status. The annotations are as follows:

Tentative information: This is the most tentative form of information and represents a very preliminary specification. No actual design work on the product has been started.

Preliminary Information: The product is in design and development. The datasheet represents the product as it is understood but details may change.

Advance Information: The product design is complete and final characterisation for volume production is well in hand.

No Annotation: The product parameters are fixed and the product is available to datasheet specification.

NOTICE: The technical data are to specify components, not to guarantee their properties.No warranty or guarantee expressed or implied is made regarding delivery or performance. The Company reserves the right to alter without prior notice the specification of any product. Information concerning possible methods of use is provided as a guide only and does not constitute any guarantee that such methods of use will be satisfactory in a specific piece of equipment. It is the user's responsibility to fully determine the performance and suitability of any equipment using such information and to ensure that any publication or data used is up to date.

All brand names and product names used in this publication are trademarks, registered trademarks or trade names of their respective owners.

© SEMICODE ELECTRONICA 2013. TECHNICAL DOCUMENTATION – NOT FOR RESALE